

SLIDING AND FOLDING DOOR HARDWARE



VENTURA, CA (USA)
P.O. Box 3780
Ventura, CA 93006
PH: 800.283.9988
FAX: 800.283.4050

MEMPHIS, TN (USA)
P.O. Box 18966
Memphis, TN 38181
PH: 800.824.3018
FAX: 800.243.3656

VANCOUVER, BC (CANADA)
103-2480 Mt. Lehman Rd.
Abbotsford, BC V2T 6W3 Canada
PH: 877.535.7888
FAX: 877.535.7444

TORONTO, ON (CANADA)
160 Four Valley Rd.
Concord, ON L4K 4T9 Canada
PH: 866.243.9816
FAX: 866.243.9817



ASSA ABLOY is the global leader in door opening solutions, dedicated to satisfying end-user needs for security, safety and convenience.

SLIDING 200 SERIES - FOR SLIDING PANELS TO 200 LBS.

280A Soffit Mounted with Fascia

STANDARD

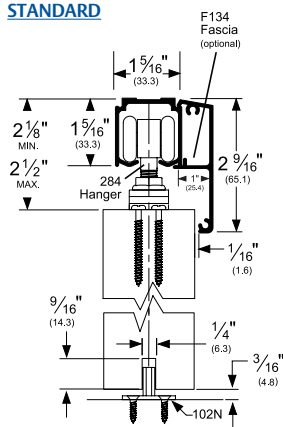

OPTIONS

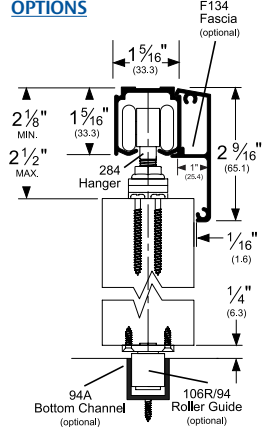

STANDARD KIT SIZES

Part Number	Material	Track Length
H200A/4	Aluminum	48"
H200A/5'4	Aluminum	64"
H200A/6	Aluminum	72"
H200A/7	Aluminum	84"
H200A/8	Aluminum	96"
H200A/10	Aluminum	120"
H200A/12	Aluminum	144"
H200/6	Steel	72"
H200/8	Steel	96"

CONFIGURATIONS:

- Single
- Bi-parting

INSTALLATIONS:

- Face Mount
- Soffit Mount
- Face/Soffit Mount with Fascia

FEATURES:

- Needle bearing hangers for smooth operation.
- 200 lbs. panel capacity.
- Galvanized steel track 280.
- Aluminum track 280A.

H200A Kits Include:

- 1 ea **280A** Track
- 2 ea **284** Hangers
- 1 ea **102N** Nylon Guide
- 2 ea **286** Stops
- 1 ea Adjusting wrench and mounting hardware

H200 Kits Include:

- 1 ea **280** Track
- 2 ea **284** Hangers
- 1 ea **102N** Nylon Guide
- 2 ea **286** Stops
- 1 ea Adjusting wrench and mounting hardware

OPTIONS:

- Hardware Kit **H200 PACK**
- Mounting Bracket **281** available as 5 pack only, **2815**
- Track Stop (bumper) **287**
- Bottom Channel **94A**
- Fascia, Snap-On **F134** (280A only)
- Roller Guide **106R/94**
- Mortise Guide **102WA**
- Threshold **971ANB**

FINISHES:

- 280A available in Mill Finish Aluminum (A)
- F134 Fascia available in Clear Anodized (C)

BYPASS TRACK SERIES - FOR BYPASSING PANELS TO 200 LBS.

1-3/8" Thick Doors

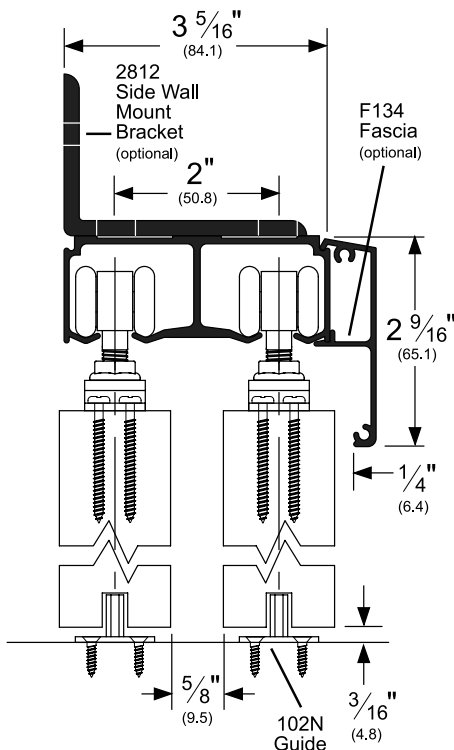

STANDARD KIT SIZES

Part Number	Track Length
HBP200A/4	48"
HBP200A/5'4	64"
HBP200A/6	72"
HBP200A/7	84"
HBP200A/8	96"
HBP200A/10	120"
HBP200A/12	144"

FEATURES:

- Fits 1-3/8" and 1-3/4" doors
- Needle-bearing wheels for ultra smooth performance
- Load capacity 200 lbs. (2 hangers)
- Extruded aluminum track

HBP200A Kits Include:

- 1 ea **2802A** Track
- 4 ea **284** Hangers
- 2 ea **102N** Nylon Guide
- 4 ea **286** Stops
- 1 ea Adjusting wrench and mounting hardware

OPTIONS:

- Hardware Kit **H200 PACK**
- Mounting Bracket **2812**
- Track Stop (bumper) **287**
- Bottom Channel **94A**
- Double Channel **2802BT**
- Fascia, Snap-On **F134**
- Roller Guide **106R/94**

FINISHES:

- 280A available in Mill Finish Aluminum (A)
- F134 Fascia in Clear Anodized (C)

FOLDING 100 SERIES - FOR FOLDING DOORS AND ROOM DIVIDERS TO 100 LBS.

280 Soffit Mounted

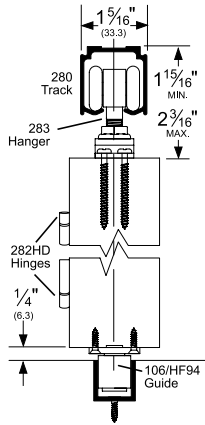

STANDARD KIT SIZES

Part Number	Material	# of Panels	Track Length
HF2/100A/2	Aluminum	2	24"
HF2/100A/2'6	Aluminum	2	30"
HF2/100A/3	Aluminum	2	36"
HF2/100A/4	Aluminum	2	48"
HF4/100A/4	Aluminum	4	48"
HF4/100A/5	Aluminum	4	60"
HF4/100A/6	Aluminum	4	72"
HF4/100A/8	Aluminum	4	96"
HF2/100/4	Steel	2	48"
HF2/100/8	Steel	4	96"

TWO PANEL:

HF2/100A Kits Include:

- 1 ea **280A** Track
- 1 ea **283** Hanger
- 1 ea **289T** Top Pivot
- 1 ea **289B** Bottom Pivot
- 3 ea **282HD** Hinges
- 1 ea **106HF/94**
- 1 ea **94** Guide Channel
- 1 ea Adjusting wrench and mounting hardware

FOUR PANEL:

HF4/100A Kits Include:

- 1 ea **280A** Track
- 2 ea **283** Hangers
- 2 ea **289T** Top Pivots
- 2 ea **289B** Bottom Pivots
- 6 ea **282HD** Hinges
- 2 ea **106HF/94** Guide
- 1 ea **94** Guide Channel
- 1 ea Adjusting wrench and mounting hardware

OPTIONS:

- Mounting Bracket **281** available as 5 pack only, **2815**
- Threshold **971ANB**

FINISHES:

280A available in Mill Finish Aluminum (A) and 280D Dark Bronze (D)

SLIDING GLASS SERIES

CAPACITY:

- Max. door weight 165 lbs. (75kg)
- Max. door height 7' 10" (2400mm)
- Max. door width 4' 1" (1250mm)
- Glass thickness 5/16" (8mm) & 3/8" (10mm)

DOOR TYPES:

Glass panels of 5/16" (8mm) or 3/8" (10mm) thickness in tempered or laminated glass.

FINISHES:

280A available in Mill Finish Aluminum (A)
F136 Fascia available in Clear Anodized (C)

8/10/75HUSKY Kits Include:

- 2 - Hangers **284D**
- 2 - **GLASS CLAMPS** w/anti-lift stop
- 2 - End stops **601H**
- 2 - Guides **610** (1) and **608** (1)

NOTE: When using glass clamps in combination with protective coatings for glass surfaces such as Clear Shield, ensure that the glass surface to be clamped is not treated with the Clear Shield coating.

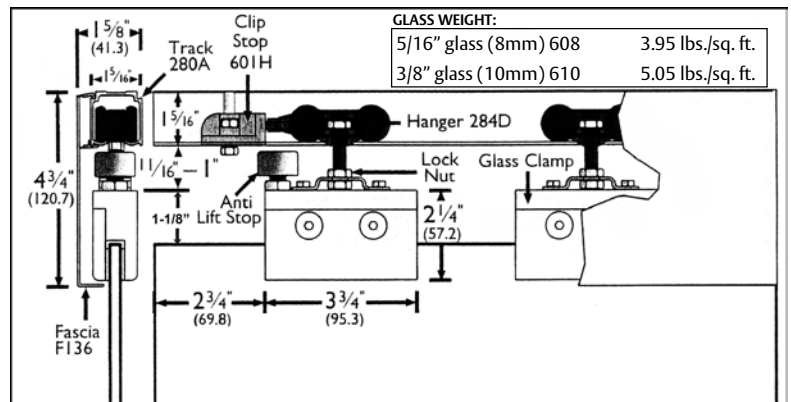

TECHNICAL INFORMATION:

- Track: **280A** (extruded aluminum)
Available in 6', 8' & 12' lengths
- Face mount bracket: **281** available as 5 pack only, **2815**
- Fascias: Soffit Fixed Track, **F136**
- Glass clamp kits: **8/10/75HUSKY** - 8mm or 10mm glass
- Guides: **608** and **610** glass guides
- Accessories: **601H** retaining stop mounted within the track

SIDE WALL TRACK (SWT) SYSTEM

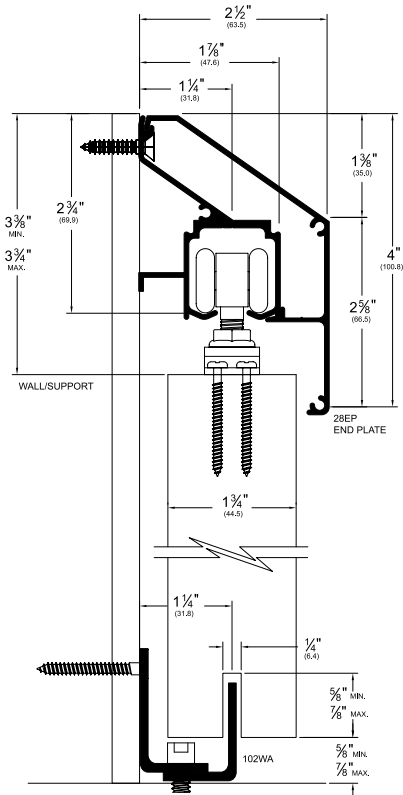

STANDARD KIT SIZES	
Part Number	Track Length
(Aluminum Fascia/End Plates)	
280SWTKIT/5	60"
280SWTKIT/6	72"
280SWTKIT/8	96"
280SWTKIT/12	144"
(Dark Bronze Anodized Fascia/End Plates)	
280DSWTKIT/5	60"
280DSWTKIT/6	72"
280DSWTKIT/8	96"
280DSWTKIT/12	144"

CONFIGURATIONS:

- New Construction
- Retro-Fit
- Single
- Bi-Parting

280SWT Kits Include:

Side Wall Track
280SWT60 (5 ft.)
280SWT72 (6 ft.)

Side Wall Fascia
280SWF60 (5 ft.)
280SWF72 (6 ft.)
280SWF96 (8 ft.)

Side Wall End Plates
K28SWEP (2 each)

Hangers

284 (2 each)
 Nylon-Bodied, Needle Bearing, Acetal Wheel

Stops

286 (2 each)

Bottom Guide-Nylon Door

102N (1 each)
102WA (1 each)

OPTIONS:

Hardware Kit (one door) **H200 PACK**
 Roller Guide **106R/94**
 Bottom Channel **94A**
 Mortise Guide **102WA**
 Threshold **971ANB**

POCKET FRAME KIT

- Heavy-duty hardware (up to 200 lb. capacity)
- Suitable for 1-3/8" to 1-3/4" doors
- Extruded, non-rusting aluminum track
- Knock-down construction
- Extruded, aluminum reinforced studs (minimizes bowing effect)

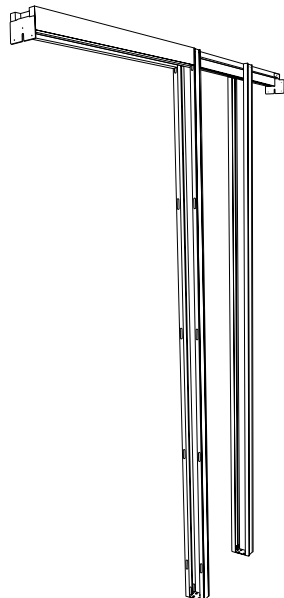

OPTIONS:

- PF134** - Required for 1-3/4" doors
- PFAS88** - An extra pair of 88" center studs with floor cleat for 84" tall doors
- PFAS100** - An extra pair of 100" center studs with floor cleat for 96" tall doors
- PFCDKIT** - Conversion Kit to achieve a double door frame

ROUGH FRAME OPENING DIMENSIONS:

2x Door Width + 1"
 - and -
 Door Height + 5"

KIT NUMBER

KIT SIZE

2x4 Wall

(Can be trimmed in field)

PF28200A6080	2'6" x 6'8"
PF28200A7280	3'0" x 6'8"
PF28200A9680	4'0" x 6'8"
PF28200A6084	2'6" x 7'0"
PF28200A7284	3'0" x 7'0"
PF28200A9684	4'0" x 7'0"
PF28200A6096	2'6" x 8'0"
PF28200A7296	3'0" x 8'0"
PF28200A9696	4'0" x 8'0"

2x6 Wall

PF28200A6080-2x6	2'6" x 6'8"
PF28200A7280-2x6	3'0" x 6'8"
PF28200A9680-2x6	4'0" x 6'8"
PF28200A6084-2x6	2'6" x 7'0"
PF28200A7284-2x6	3'0" x 7'0"
PF28200A9684-2x6	4'0" x 7'0"
PF28200A6096-2x6	2'6" x 8'0"
PF28200A7296-2x6	3'0" x 8'0"
PF28200A9696-2x6	4'0" x 8'0"

* Custom sizes available - call for information